

13 12 11 10 9 8 7 6 5 4 3 2 1

J
I
H
G
F
E
D
C
B
A

J
I
H
G
F
E
D
C
B
A

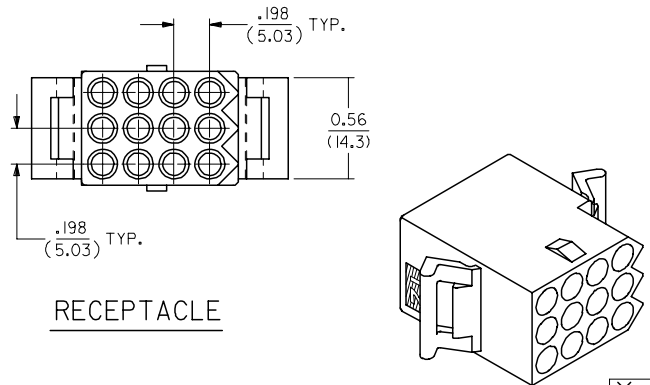
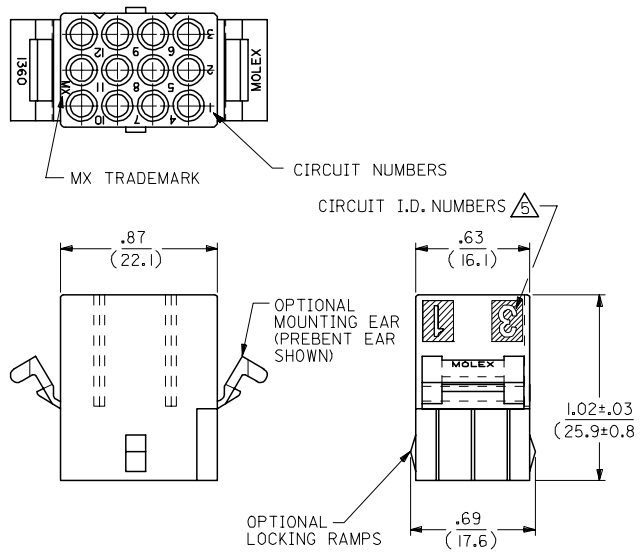

RECEPTACLE

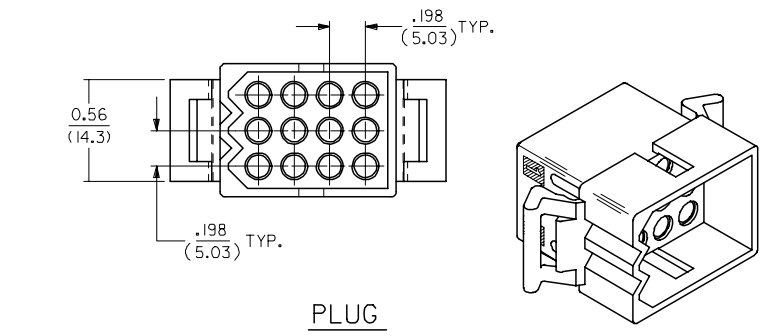
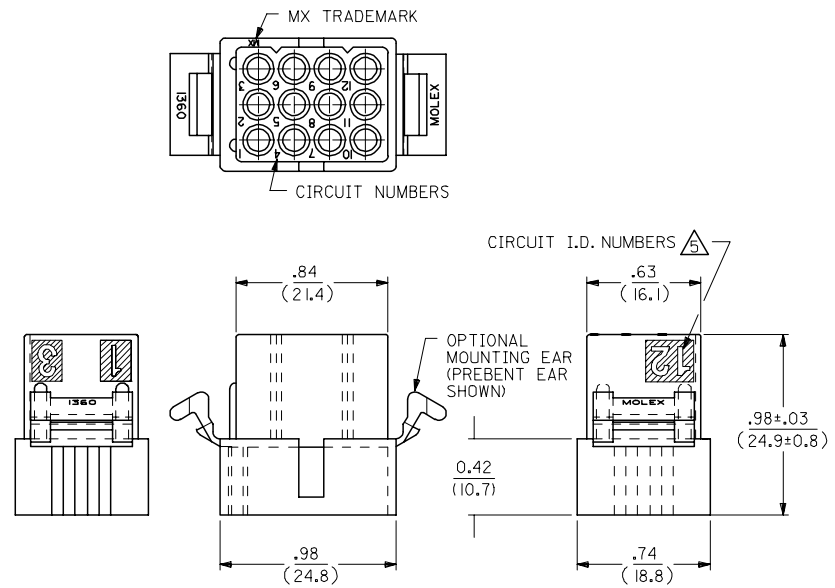

PLUG

UPDATE TITLE BLOCK EC NO: UCP2006-0080 DRAWN: JLOME CHKD: 2005/07/20 APPR: FSM TH 2005/07/21 REV DESCRIPTION	QUALITY SYMBOLS	GENERAL TOLERANCES (UNLESS SPECIFIED)	DIMENSION STYLE	SCALE	DESIGN UNITS	THIRD ANGLE PROJECTION
	$\nabla=0$ $\nabla=0$	mm INCH 4 PLACES ± --- ± --- 3 PLACES ± --- ± .010 2 PLACES ± 0.25 ± .014 1 PLACE ± 0.35 ± --- ANGULAR ± 2 °	IN/MM DRAWN BY DATE KBW 3/1/89 CHECKED BY DATE RW 3/1/89 APPROVED BY DATE RAS 3/1/89	2:1	INCH	
	DRAFT WHERE APPLICABLE MUST REMAIN WITHIN DIMENSIONS	SEE CHART SIZE C	MATERIAL NO. DOCUMENT NO.	TITLE .093/(2.36) HOUSINGS PLUG AND RECEPTACLE 12 CKT, .198/(5.03)CTR.	MOLEX MOLEX INCORPORATED	SHEET NO. 1 OF 2
	AE1					

2	AE1
1	AE1
SHT/REV	

12 11 10 9 8 7 6 5 4 3 2 1

PLUG		
ORDER NO	ENG NO	
03-09-2121	I360-P	
03-09-2122 \triangle	I360-P1	
03-09-7121	I360-PBK	
03-09-7122 \triangle	I360-P1BK	OBSOLETE

RECEPTACLE	
ORDER NO	ENG NO
03-09-1121	I360-R
03-09-1122	I360-R1
03-09-1125	I360-R2
03-09-1126	I360-R3
03-09-6121	I360-RBK
03-09-6122	I360-R1BK
03-09-6125	I360-R2BK
03-09-6126	I360-R3BK
03-09-6123	I360-R1RD
03-09-6124	I360-R1YW

LEGEND: PLUG

I360-P***

P = PLUG

BLANK = WITHOUT EARS

I = WITH MOUNTING EARS

COLOR:

BLANK = NATURAL COLOR

AM = AMBER BK = BLACK BU = BLUE

BN = BROWN GY = GRAY GN = GREEN

OR = ORANGE RD = RED YW = YELLOW

LEGEND: RECEPTACLE

I360-R***

R = RECEPTACLE

BLANK = WITH PREBENT EARS ONLY

1 = WITHOUT EARS/WITHOUT LOCKING RAMP

2 = WITH PREBENT EARS & LOCKING RAMP

3 = WITH LOCKING RAMP ONLY

COLOR:

BLANK = NATURAL COLOR

AM = AMBER BK = BLACK BU = BLUE

BN = BROWN GY = GRAY GN = GREEN

OR = ORANGE RD = RED YW = YELLOW

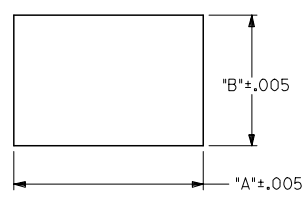
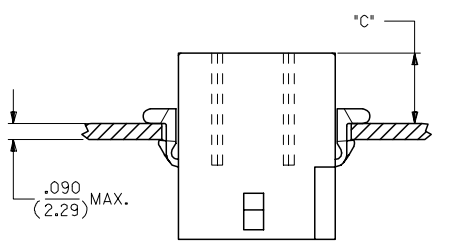

RECOMMENDED PANEL OPENING

HOUSING	DIM. 'A'	DIM. 'B'	'C' PREBENT EAR	'C' STANDARD EAR
PLUG	1.155/(29.34)	.760/(19.30)	.40/(10.2)	.36/(9.1)
RECEPT.	1.050/(26.67)	.725/(18.42)	.41/(10.4)	.37/(9.4)

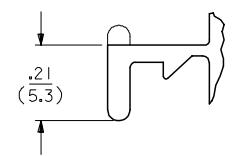

DETAIL A
.093/(2.36) STANDARD MOUNTING EAR
(SCALE 4:1)

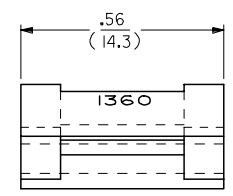

DETAIL B
.093/(2.36)PREBENT MOUNTING EAR
(SCALE 4:1)

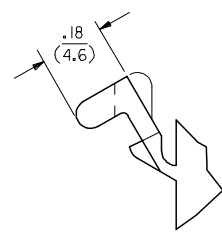

- NOTES:
- MATERIAL: NYLON TYPE 6/6, UL94V-2
 - FINISH: N/A
 - PRODUCT SPECIFICATION: PS-02-09, PS-43660-9999
 - PACKAGING SPECIFICATION: PK-1360-001
- \triangle CIRCUIT I.D. NUMBERS ON SIDE OF HOUSING APPEAR ON PARTS FROM TOOLS BUILT AFTER 10/22/91
- \triangle WHERE DENOTED IN CHART, TOOLS ARE BUILT WITH PREBENT MOUNTING EARS PER DETAIL B AND SUPERSEDE ALL TOOLS PREVIOUSLY BUILT WITH THE STANDARD EARS.

UPDATE TITLE BLOCK EC NO: UCP2006-0080 DRAWN: JLOME CHKD: 2005/07/20 APPR: FSM TH 2005/07/21	QUALITY SYMBOLS ▽=0 ▽=0	GENERAL TOLERANCES (UNLESS SPECIFIED)		DIMENSION STYLE		SCALE	DESIGN UNITS	THIRD ANGLE PROJECTION	
				IN/MM		2:1	INCH		
		4 PLACES ± .010	± .010	DRAWN BY	DATE	.093/(2.36) HOUSINGS PLUG AND RECEPTACLE 12 CKT, .198/(5.03)CTR.			
		3 PLACES ± .014	± .014	KBW	3/1/89				
2 PLACES ± .025	± .014	CHECKED BY	DATE	MOLEX INCORPORATED MATERIAL NO. SD-1360-* DOCUMENT NO. SHEET NO. 2 OF 2					
1 PLACE ± .035	± .014	RW	3/1/89						
ANGULAR ± 2 °		APPROVED BY	DATE						
		RAS	3/1/89						
DRAFT WHERE APPLICABLE MUST REMAIN WITHIN DIMENSIONS		SEE CHART							
		MATERIAL NO.							
		SIZE							
		C		THIS DRAWING CONTAINS INFORMATION THAT IS PROPRIETARY TO MOLEX INCORPORATED AND SHOULD NOT BE USED WITHOUT WRITTEN PERMISSION					